



What we need from you...

- Ideally we will require a drawing of your application, indicating all existing posts, distances between them and exactly where you would like to have your door placement relative to the house wall or to a front corner. There is a sample of one of our customer submissions below. Nothing fancy... you can either fax it to **705.325.0252** or scan / email your drawing to... requests@screen-house.com
- If you have no existing posts, give projection (away from wall) and width dimensions and again your door placement relative to the house wall or to a front corner.
- Lastly we will need to know the highest dimension from floor (deck or patio) to existing roof line AND... whether you require a bottom kick-plate (which can be none, 18" or 24").

Once we have reviewed your drawing and asked any remaining questions (be sure to include your name, phone number and email address), we will send you your quotation which will include cost, details and a drawing that indicates how to use the material. The drawing to the right is a sample of what you will get with your "no obligation" quotation...

You can use the attached blank page to do your drawing

You submit something like this...

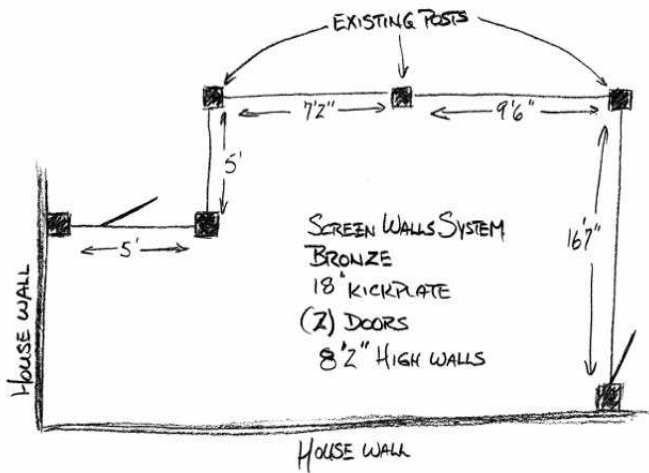

You get back something like this...

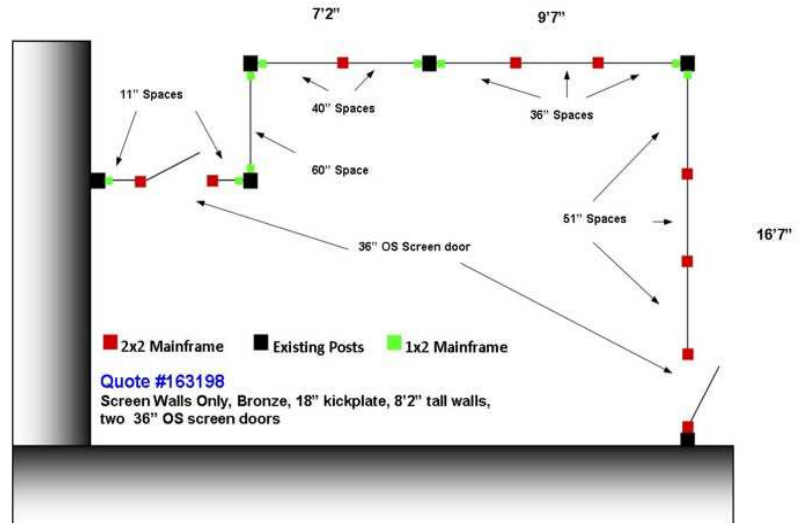

Name: _____

Telephone: _____

Email: _____

Door Placement: On the drawing you provide indicate where you would like the door. Indicate (____ inches) where the door is relative to a corner or the house wall

Height (maximum heights of wall(s)) _____' _____"

Kickplate: NO 18" Kickplate 24" Kickplate

Frame Color: Bronze Clay White



Name: _____

Height (maximum heights of wall(s)) _____' _____"

Telephone: _____

Kickplate: NO 18" Kickplate 24" Kickplate

Email: _____

Frame Color: Bronze Clay White

Door Placement: On the drawing you provide indicate where you would like the door. Indicate (_____) inches where the door is relative to a corner or the house wall



Fill in the information required and fax or email the front sheet (and your drawing)...

Fax: 705.325.0252

Email: requests@screen-house.com

You will be getting 16' and 20' lengths of each of the four following profiles. You will be cutting your exact sizes of material from these lengths and putting the screen framing together - much like an "Erecto-Set!"

Not included in your kit:

- Screws to attach u-channel to house wall.
- Sealant for u-channel to concrete or floor connection. We suggest using Tapcon screws in addition to the sealant.
- Screen roller to insert screen and round vinyl spline

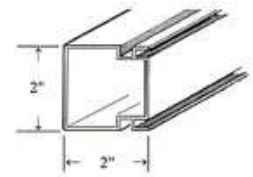

H122 - Vertical supports

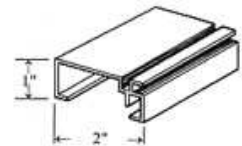

H121 - Horizontal supports...top, bottom and mullion

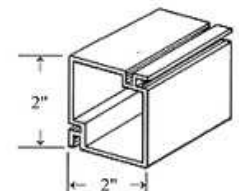

H120 - Used in place of the H122 on a corner

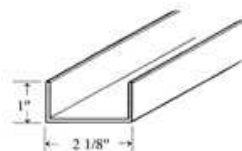

H123 - top and bottom U channels

H123 1" x 2" U channel
(H124 2" x 2" U channel on sloped areas)

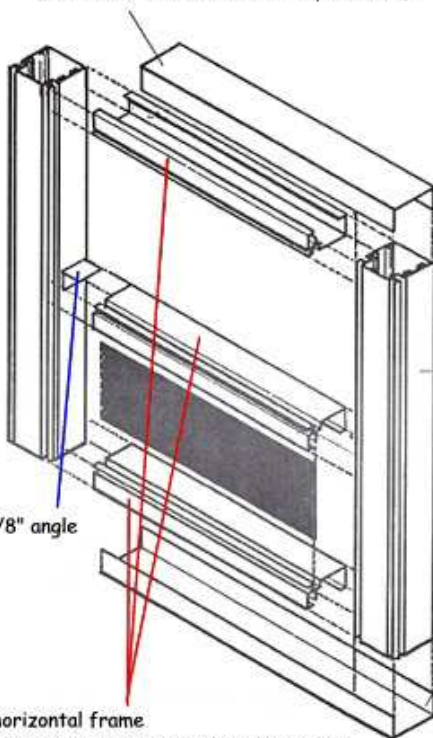

H122 2" x 2" vertical mainframe
(H120 2" x 2" mainframe substituted at corners)

H123 1" x 2" U channel

H126 7/8" x 7/8" angle
Mullion Clip

H121 1" x 2" horizontal frame
(The center part can be replaced with a 2"x2" H122 when there is no kickplate option being used)